

M318F

Wheeled Excavator



Engine

Engine Model	Cat® C7.1 ACERT™	
Emissions	U.S. EPA Tier 4 Final	
Net Power (maximum)		
ISO 9249 at 1,750 rpm	126 kW	169 hp
ISO 9249/SAE J1349 (metric)		171 hp (PS)
ISO 13496 at 1,750 rpm (gross)	129.4 kW	174 hp

Weights

Operating Weight	16 900 kg-	36,817 lb-
	19 700 kg	42,549 lb

Bucket Specifications

Bucket Capacities	0.35 m ³ -	0.46 yd ³ -
	1.09 m ³	1.43 yd ³

Working Ranges

Maximum Reach at Ground Level	9230 mm	30'3"
Maximum Digging Depth	5920 mm	19'5"

Drive

Maximum Travel Speed	35 km/h	22 mph
----------------------	---------	--------

M318F Features

Made to keep your costs down.

Not only does the machine give you all the versatility you need, but it does so while providing a great deal of precision, and speed with an absolute minimum fuel consumption – and zero impact on your efficiency.

Made to make operation easy and pleasant.

Have a seat, you will be impressed by the quietness and comfort of the cab. Feel relaxed, we help you make sure you're safe.

Enjoy integrated technologies; they act transparently.

When you add the ground level grouped service points that make your maintenance quick and easy, and multiple Cat work tools that help you do all kinds of jobs, you simply won't find a better machine.

Contents

Sustainability	4
Engine	5
Built-in Fuel Savers That Add Up	5
Premium Comfort	6
Simplicity and Functionality	7
The Next Generation	8
Cruise Control	8
Smart Technologies	9
Dig and Go Auto Axle Lock	9
Hydraulics	10
Undercarriage	11
Booms and Sticks	12
SmartBoom™	13
Ride Control	13
Work Tools	14
Serviceability	16
Integrated Technologies	17
Safety	18
Unmatched Visibility	20
Complete Customer Care	20
Specifications	21
Standard Equipment	33
Optional Equipment	34
Notes	35





The new F Series generation is here to help you take on the wide variety of challenges you face every day, more easily and with more pleasure.

F Series – Easier Than Ever.



Sustainability

Generations Ahead in Every Way

Fuel Efficiency and Reduced Exhaust Emissions

The engine meets Tier 4 Final emission standards, performs the same amount of work, while burning significantly less fuel than the previous model, which means more efficiency, less resources, and fewer CO₂ emissions.

Quiet Operation

Outstandingly low sound levels, you won't believe your machine is running.

Transparent Technologies and Longer Service Intervals

- The new Eco Modes, Auto Engine Speed Control and Engine Idle Shutdown help further reduce your overall fuel consumption.
- Product Link™ allows remote monitoring of the machine and helps improve overall efficiency.
- Your Cat dealer can help extend service intervals, meaning fewer fluids and disposals, all adding up to lower costs.

Biodiesel and Biodegradable Hydraulic Oil

- The M318F has the flexibility of running on either ultra-low-sulfur diesel (ULSD) fuel with 15 ppm of sulfur or less or up to B20 biodiesel fuel blended with ULSD.
- Cat BIO HYDO™ Advanced HEES™ reduces the impact on the environment.

Cat Certified Used

This program is a key element in the range of solutions offered by Caterpillar and Cat dealers to help customers achieve growth at the lowest cost while eliminating waste. Used equipment is inspected, guaranteed and ready for work and customers will benefit from a Caterpillar warranty.

Engine

Power, Reliability, and Fuel Economy



The Power and Performance You Need

Constant Power Strategy

Provides a quick response to changing loads, while delivering the same amount of power regardless of operating conditions.

A Transparent Emission Solution That Works.

The Cat C7.1 ACERT engine meets today's Tier 4 Final emission standards, and it does so without interrupting your job process. It is designed to be:

- **Transparent:** no operator intervention
- **Durable:** fit for life Diesel Particulate Filter
- **Efficient:** no work interruption, even in case of extended idling time
- **Simple:** minimum maintenance. Longitudinal engine installation, which further simplifies maintenance.

Biodiesel Not a Problem

The engine can run on up to B20 biodiesel fuel that meets ASTM 6751 standards – all to give you more potential fuel-saving flexibility.

Proven Technology

To assure that our technology will meet your expectations for reliable trouble-free service, we subjected these engines and technologies to extensive operating hours of test and validation.

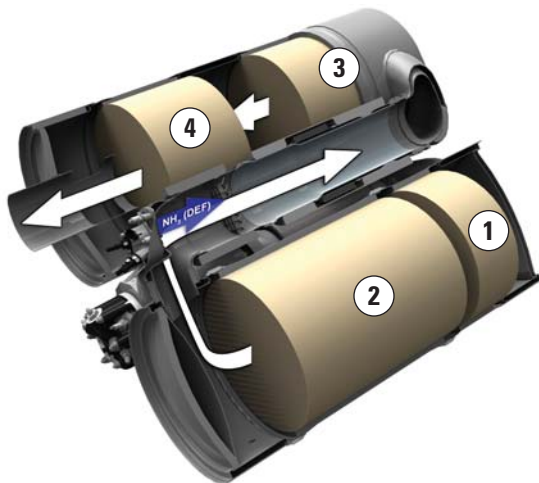

1) DOC 2) DPF 3) SCR Catalyst 4) AMOX

Built-in Fuel Savers That Add Up

- Automatic Engine Speed Control: lowers engine speed when it is not needed.
- NEW Engine Idle Shutdown (when activated): turns the engine off when it's been idling for more than a pre-set amount of time.
- NEW Cooling System: variable speed and on-demand fan optimizing consumption.
- NEW enhanced Eco Mode: reduces engine speed while delivering the same power.
- Automatic shift to Travel Mode when you start riding: optimizes driveline performance while preserving fuel.

Premium Comfort

Keeps Operators Productive All Shift Long



Legacy from the Renowned Cat Wheeled Excavators

Designed for the operator, our cabs are unique.

Ergonomic Layout

- Frequently used switches are centralized, kept to the minimum and ideally located close to the joysticks.
- Storage compartments are useful... when well designed. The lunch box provides sufficient room to store a hard hat. Several other areas include drink, phone, or key holders.

Comfortable Seat Options

Our seats provide all the comfort needed for a long day of work, including FULL adjustment. All seats are heated and air suspended. Automatic weight adjustment and air cooled seats are available.

Safety – Not an Option

ROPS/FOGS compatible cabs, seat belt alarm, safety bar, sideview camera ... among others.

Details That Make the Difference

Have a look at the cab; you will see it is through details that we improve pleasure of operating.

Smart Controls to Reduce Fatigue

- Features like ride control, SmartBoom or Joystick Steering will be precious to increase your productivity.
- New technologies that work transparently like the swing and auto travel lock or the automatic brake and axle lock, reduce the number of tasks you need to do.

Plug, Charge and Play Your Devices

- The 12V 10A power supply socket is conveniently located for charging your laptop, or a tablet.
- A CD/MP3 Radio with speakers and USB port is available.





Simplicity and Functionality

For Ease of Operation

A Cab Just for You – Fully Adjustable

- Joystick consoles, in height and angle
- Steering column adjustment, not only tilting fore/aft but also in height
- Hydraulic sensitivity of the machine to make it more or less aggressive
- Joystick controls, buttons and thumb wheels
- Automatic air conditioning

Incredibly Low Sound Levels, Less Fatigue

Increased cab pressure, preventing from dust entry, combined with the new design contributes to reducing sound. Add in new hydro mounts to fix the cab on the frame and you have a cab that's as quiet as any of today's pickup trucks.

Outstanding Visibility: See the Difference!

- Standard LED working lights and halogen roading lights
- LED dome light
- All glass areas have been drastically increased
- Choice of 70/30 front windshield or one-piece windshield
- New wide angle mirrors including a lower mirror for better visibility to the ground
- Parallel intermittent (four speeds) wipers covering the whole windshield

Standard Rear and Side Wide Angle Cameras

Cameras let you see what's going on around. The image from the side camera is displayed on an additional wide color screen, offering the full view from the front to the rear of the machine. The rear camera is integrated into the counterweight for enhanced protection.

Large Color Monitor

Easy to read and in local language, the high resolution LCD monitor will keep you aware of any important information. "Quick Access" buttons allow a quick selection of favorite functions. The tool select function lets you preset up to ten different hydraulic attachments for quick tool changes.

The Next Generation

Easier Than Ever



Make the Move to the Next Generation

Refinements. From the whole design to the smallest details. Convenient features, new advanced and transparent technologies, not only to reduce emissions but to further improve your daily experience when working with our products.

Easier Than Ever

Work like no other with our wheeled excavators. The F Series generation is made to help you take on the wide variety of the challenges you face every day, more easily and with more pleasure, to keep you on the road to your success.

Cruise Control

Focus on the Road, Not on Your Foot



Cruise Control

No need to press the pedal all the time.

- Choose the very speed you wish
- Press the quick access button on the monitor
- Enjoy the ride

It's as Easy as That.

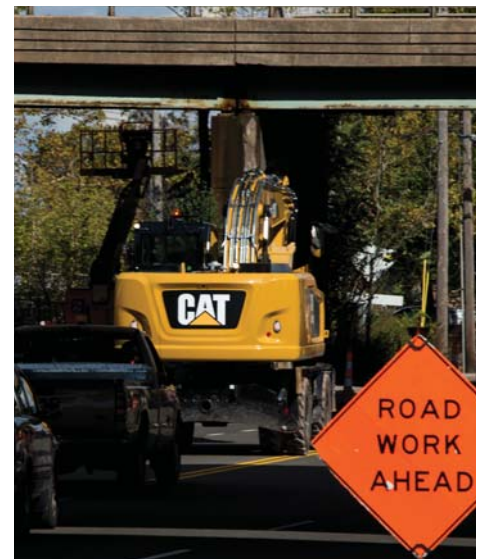

Smart Technologies

Press Go and Relax

Swing and Auto Travel Lock: As Fast, As Easy, As Safe

No need for the operator to bend to engage the swing lock pin.

- Just press a button,
- Align the upper to the lower frame,
- Enjoy the ride: a green indicator confirms the swing and the implements have been automatically locked.

It's As Easy As That.

Integrated Pin Code – Switch Off and Relax

No need to buy an optional security system to protect your equipment against theft.

- The pin code is integrated into the monitor (standard)
- Entering the right code allows the engine to start

The Machine Security System (MSS – optional) adds even more protection when needed.

It's as Easy as That.



Dig and Go Auto Axle Lock

Presses the pedal for you, reducing the number of actions you need to do

The machine automatically detects when the service brake and axle need to be locked (like when digging), or unlocked (roading), hence removing the need for the operator to systematically press the pedal.

Brake and axle are released automatically by pressing the travel pedal again.



Hydraulics

Fast, Precise, Flexible

When it comes to moving material quickly, you need efficient hydraulics – the type the F Series can deliver.

Efficient Design, Smart and Fast

- **Simple Design:** The new hydraulic valve compartment and routings offer a simple and clean design to help ensure durability. Everything is reachable from ground level.
- **Smart Main Hydraulics:** The system allows reducing the load on the engine when not needed, which translates into lower fuel consumption.
- **Dedicated Secondary Hydraulics:** A closed hydraulic circuit is dedicated to the swing only. Having two separate pumps, one for the swing and the other for the other functions allows faster and smoother combined movements.

Control Like No Other

- **Electronic Pump Control** – Controllability is one of the main attributes of Cat excavators, and one of the key contributors to this is the Electronic Pump Control (EPC) that's designed to improve response time and precision. It puts flow exactly where you need it, when you need it, which means a much smoother operation and greater efficiency.
- **Adjustable Hydraulic Sensitivity** – Allows you to adjust the aggressiveness of the machine according to the application.
- **Stick Regeneration Circuit** – Increases efficiency and helps enhance controllability for higher productivity.

Proportional Auxiliary Hydraulics, Tremendous Versatility

Medium pressure function (for tilting buckets or rotating tools), high pressure lines (for tilting/rotating work tools requiring a third auxiliary hydraulic function), hydraulic quick coupler circuit: they all come standard, which allows you to switch from one work tool to another, without the need to add lines and hydraulic circuits.

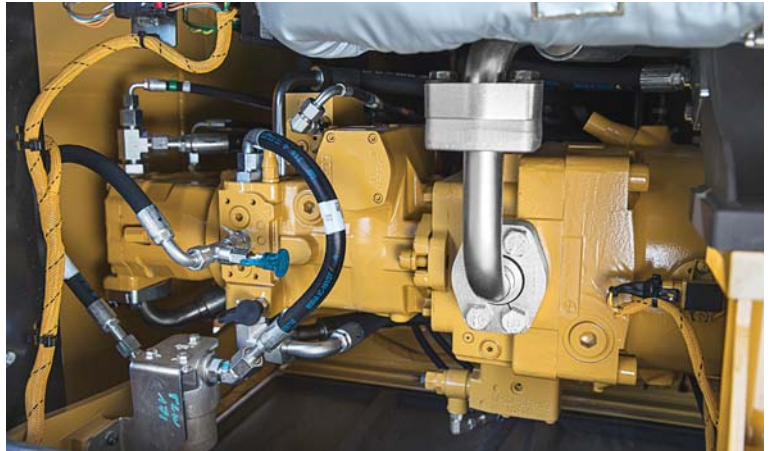



Undercarriage

Strength and Versatility at 35 km/h (22 mph)



Heavy Duty Axles

Long life with effective heavy duty axles. The transmission is mounted directly on the rear axle for protection and optimum ground clearance. The front axle offers wide oscillating and steering angles.

Advanced Disc Brake System

Minimizes the rocking effect when working free on wheels. The disc brake system acts directly on the hub instead of the drive shaft to avoid planetary gear backlash.



Fenders (optional)

Fenders provide excellent coverage of all tires, protecting the machine and surroundings from mud and stones being thrown up.



Joystick Steering

Keep both hands on the joysticks even when simultaneously moving the implements and repositioning the machine, by the use of the slider switch on the right joystick.

New Blade Design

- Parallel kinematic to keep the blade parallel to the ground, in every height position
- A profile that allows material to roll better and minimizes material packing

Booms and Sticks

Options To Take on Your Far-reaching or Up-close Tasks

Rugged Performance

Booms and sticks are welded, box section structures with thick, multi-plate fabrications in high stress areas for the tough work you do.

Flexibility

The choice of various booms and sticks provides the right balance of reach and digging forces for all applications.

Sticks

- **Short stick – 2100 mm (6'11")** for maximum breakout force and lifting capability
- **Medium stick – 2400 mm (7'10")** for greater crowd force and lift capacity
- **Long stick – 2600 mm (8'6")** for greater depth and reach

Booms

- **Variable Adjustable (VA)** – improved right side visibility and roading balance. When working in tight quarters or lifting heavy loads, the VA boom offers the best flexibility.
- **One-Piece Boom** – Fits best for all standard applications such as truck loading and digging. A unique straight section in the curve of the side plate reduces stress flow and helps increase boom life.
- **Offset Boom** – The large offset dimensions allow you to dig along walls, over obstacles, to grade while driving, and to dig under laid tubes without damaging them. The combination with a tiltable ditch cleaning bucket lets you operate a highly versatile system.



SmartBoom

Reduces Stress and Vibration

Rock Scraping

Scraping rock and finishing work is easy and fast. SmartBoom simplifies the task and allows more focus on stick and bucket, while the boom freely goes up and down without using pump flow.

Hammer Work

The front parts automatically follow the hammer while penetrating the rock. Blank shots or excessive force on the hammer are avoided resulting in longer life for the hammer and the machine. Similar advantages with vibratory plate compactors.

Truck Loading

Loading trucks from a bench is more productive and fuel efficient as the return cycle is reduced while the boom down function does not require pump flow.

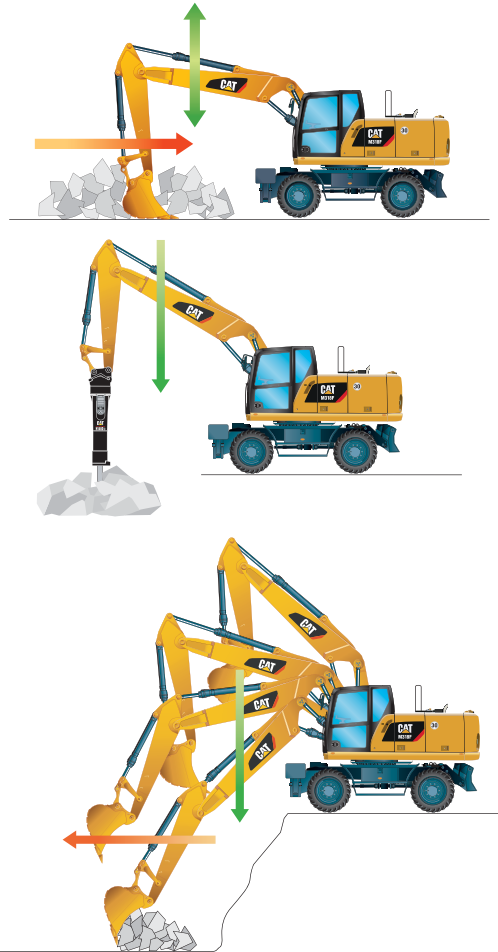

Ride Control

Fast Travel Speed with More Comfort

The ride control system lets you travel faster over rough terrain with improved ride quality for the operator. Accumulators are acting as shock absorbers to dampen the front part motion. It can be activated through a button located on the soft switch panel in the cab.



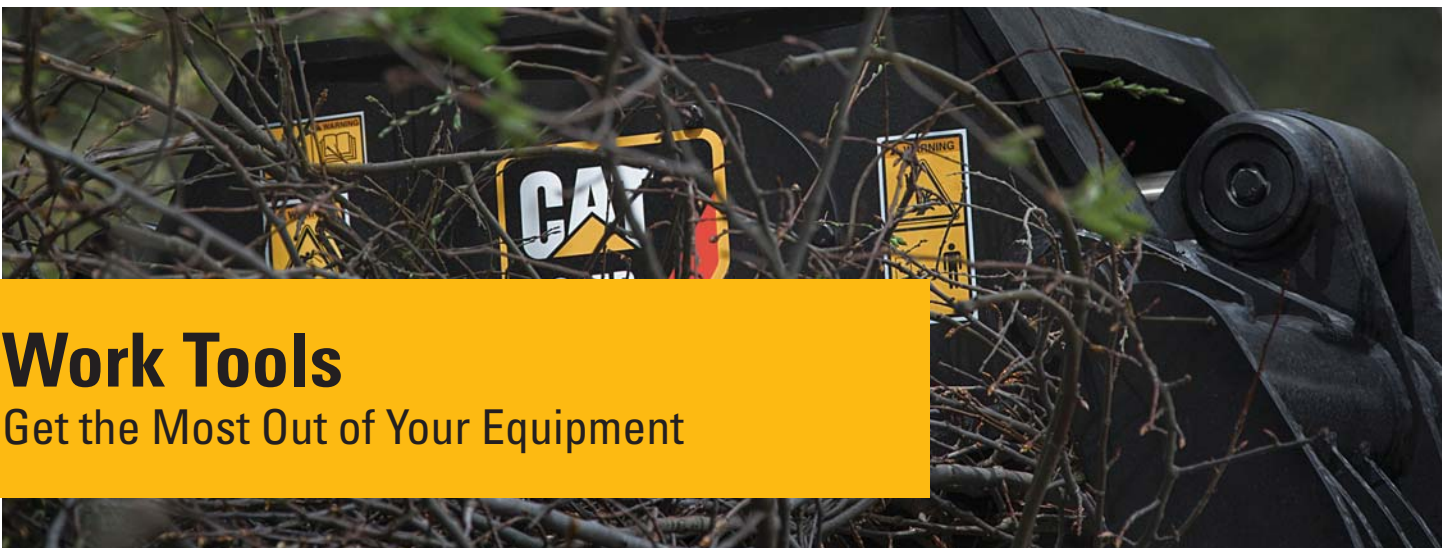

Work Tools

Get the Most Out of Your Equipment



Save Time with Tool Changes

Job Site Confidence ... From the operator's seat, visual and audible indicators help assure that the attachment is coupled. Your Cat excavator hydraulics, mechanisms inside the coupler, and digging forces all work together to assure the attachment stays engaged. The Cat Pin Grabber coupler is the secure way to decrease downtime by allowing quick attachment change, and increase job site flexibility.



Power Match

Match your Cat hydraulic work tools attachment to your Cat machine, and get the most out of the standard, built-in software. Work tool changes have never been easier!

Get the Most from Your Machine

If you have multiple tasks to get done, the M318F can help. And you can easily expand all the possibilities it offers by utilizing any of the variety of Cat attachments.

Dig, Load, Finish and Compact

A wide range of buckets offers solutions for digging, trenching, loading and finishing works. The addition of a Cat Compactor will introduce your machine to utility work, site prep, road repair and pipeline work.



Move and Handle Material

Choose from one of three different thumb styles to work with your bucket and you have the instant ability to move and handle brush, rocks and debris.

Demolish and Break

Our hammer includes a buffer to improve your comfort and protect your machine from vibration. Fully enclosed, it is ideal when working in noise regulated areas.



Sort and Load

Demolition and Sorting Grapples bring your machine into demolition and waste handling opportunities. Jaws open wide to move volumes, yet are nimble enough to pull a single copper wire out of a pile. Their 360° rotation capability allows you to place the grapple where you want it without moving the machine.

Scrap and Recycle

Shears also have the ability to rotate 360°. A pulverizer allows you to crush and reduce concrete.

Serviceability

When Uptime Counts

Convenient Access Built In

You can reach routine maintenance items like fuel and engine oil filters and fluid taps at ground level while fuel and DEF tank with engine air filter are accessible from the safety of the slip-resistant new service platform. Compartments feature wide composite service doors, designed to be more resistant to shocks, which all include gas struts to facilitate the opening. Components are now gathered in specific dedicated compartments, like the special electrical compartments.

A Cool Design for Any Temperature

The side-by-side and radial fan design allows greater cooling performance. The system is completely separated from the engine compartment to reduce noise and heat and all radiators are gathered in the same compartment while featuring easy-to-clean cores with a tilting device that requires no tool to unlock.

A Fresh Idea

Ventilation inside the cab allows outside air to enter through a fresh air filter. The filter is located on the side of the cab to make it easy to reach, and it is protected by a lockable door that can be opened with the engine key.

Lube and Fuel Options

An electric lubricator system is an available time-saving standard feature for greasing the whole upper carriage. Greasing points for the undercarriage are kept to a minimum and grouped. An electric refueling pump is also standard. The hose is stored in a dedicated tray, for more cleanliness. Add in the new electric lift pump removing the need to prime the system manually, the standard fuel and water separator and you get a machine that does the fastidious works for you.

Keep it simple.



Integrated Technologies

It Pays to Know



Cat Connect makes smart use of technology and services to improve your job site efficiency. Using the data from technology-equipped machines, you'll get more information and insight into your equipment and operations than ever before.

Cat Connect technologies offer improvements in these key areas:



EQUIPMENT MANAGEMENT

Equipment Management – increase uptime and reduce operating costs.



PRODUCTIVITY

Productivity – monitor production and manage job site efficiency.



SAFETY

Safety – enhance job site awareness to keep your people and equipment safe.

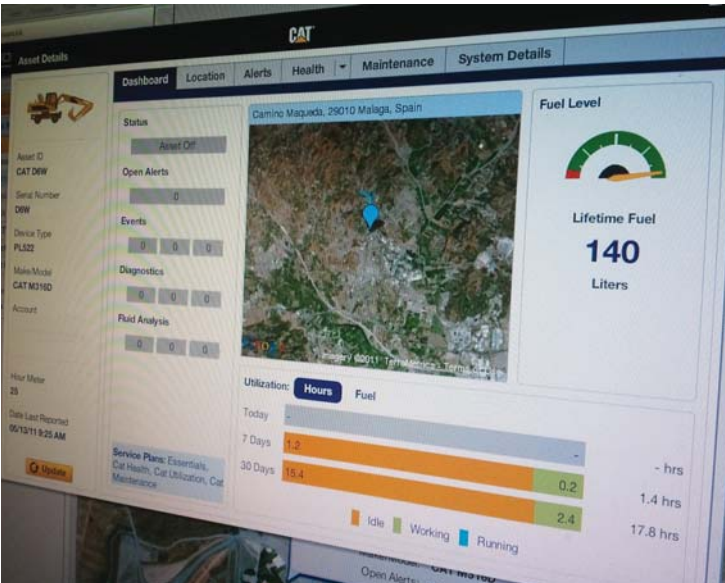

Featured Cat Connect technologies include the following:

Link

Link technologies provide wireless capability to machines to enable two-way transfer of information collected by on-board sensors, control modules, and other Cat Connect technologies.

Manage Your Machine Remotely

Cat Product Link is a system that is deeply integrated into the machine monitoring system to take the guesswork out of managing your equipment. The system tracks location, hours, fuel usage, productivity, idle time, and diagnostic codes and shares it with you through VisionLink® to help you maximize efficiency, improve productivity, and lower operating costs.

CAT® CONNECT



EQUIPMENT MANAGEMENT



PRODUCTIVITY



SAFETY



SUSTAINABILITY

Safety

Your Safety Is NOT An Option

Embedded Features

Smart devices are embedded to offer as much safety as possible for your operators and help enforce safe behavior:

- Safety seat belt and warning indicators (monitor)
- Automatic swing lock
- Automatic brake and axle lock
- Safety Lever, preventing exit when the implements are not locked out
- Emergency shut off switch and battery switch disconnect
- Adjustable travel alarm
- Lowering check valves

Safe and Quiet Cab

The all-new cab provides you with a safe environment. It also contributes to your comfort with limited vibrations and drastically reduced sound levels.



Access into the cab of a wheeled excavator has always been a challenge. We bring a solution to allow you to safely climb into the cab:

- Three longer access steps, aligned with the cab entry
- Anti-skid plates on all walkways and steps reducing slipping hazards
- New, convenient door handrail
- Safety lever built into the tiltable console to make sure the way in and out is free of obstacle



- 1) Laminated windshield and skylight window
- 2) Lowering check valves
- 3) Safety seat belt indicator
- 4) Safety lever
- 5) Emergency shut-off switch
- 6) Automatic brake and axle lock
- 7) Punched, anti-slippery walking surfaces
- 8) Battery switch disconnect
- 9) Swing and implement electronic lock
- 10) Adjustable travel alarm
- 11) All doors equipped with spring gas cylinders
- 12) Emergency hammer and exit
- 13) ROPS/FOGS compatible cab
- 14) Sound proofing
- 15) Beacon available
- 16) Falling Object Guard compatibility

Smart Lighting

- LED lights for all working lights for enhanced night-time visibility
- Halogen lights for all roading lights
- LED dome light for better illumination inside the cab



Great Views

- Enlarged glass gives you excellent visibility to the front, top, rear, and sides, even to the right
- Standard rearview camera gives you a clear field of view behind the machine through the monitor. Camera is integrated into the counterweight.
- Standard sideview camera, to check nothing is hidden to you from the front right hand side to the rear of the machine
- Lenses of all the cameras are wide angle and heated
- All mirrors are wide angle and allow view not only around the machine but also to the ground

Unmatched Visibility

Make Sure Nothing Is Hidden to You

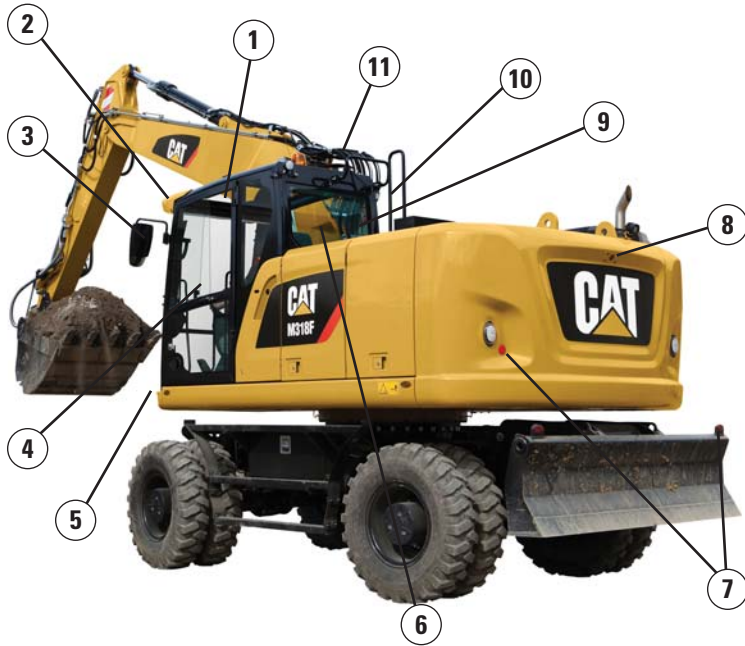

Visibility all around is critical, especially for machines which go on public roads.

- 1) Increased skylight and windshield glass area
- 2) Improved lighting with standard LED lights for all working lights
- 3) Optional heated mirrors
- 4) Great left hand side visibility with the new all glass door
- 5) Halogen roading lights
- 6) Wide rear window
- 7) Reflecting red lights on rear and blade/outriggers
- 8) Standard wide rearview camera
- 9) Standard side camera and dedicated monitor
- 10) Large right hand side window
- 11) Mirrors, wide angle, with additional lower mirror for ground visibility

Complete Customer Care

Your Cat Dealer Will Support You Like No Other

Support You Can Count On

From helping you to choose the right machine to knowledgeable on-going support, Cat dealers provide the best-in-sales and services.

- **Best long-term investment** with financing options and services
- **Productive operation** with training programs
- **Preventive maintenance** and guaranteed maintenance contracts
- **Uptime**, with best-in-class parts availability
- **Repair, rebuild, or replace?** Your dealer can help evaluate the best option.



M318F Wheeled Excavator Specifications

Engine

Engine Model	Cat C7.1 ACERT ⁽¹⁾	
Ratings	1,750 rpm	
Engine Gross Power (maximum)		
ISO 14396	129.4 kW	174 hp
ISO 14396 (metric)	176 hp (PS)	
Net Power (Rated) ⁽²⁾		
ISO 9249/SAE J1349	126 kW	169 hp
ISO 9249/SAE J1349 (metric)	171 hp (PS)	
80/1269/EEC	126 kW	169 hp
Net Power (maximum)		
ISO 9249/SAE J1349	126 kW	169 hp
ISO 9249/SAE J1349 (metric)	171 hp (PS)	
80/1269/EEC	126 kW	169 hp
Bore	105 mm	4.1 in
Stroke	135 mm	5.3 in
Displacement	7.01 L	427.8 in ³
Maximum Torque at 1,400 rpm	783 N·m	578 lbf-ft
Number of Cylinders	6	

⁽¹⁾ Meets Tier 4 Final emission standards.

⁽²⁾ Rated speed 1,750 rpm. Constant power from 1,500-1,750 rpm.

- Net power advertised is the power available at the flywheel when engine is equipped with air cleaner, CEM exhaust gas aftertreatment, alternator, and cooling fan running at intermediate speed.
- No deratings required up to 3000 m (9,842 ft) altitude. Automatic derating occurs after 3000 m (9,842 ft).

Transmission

Forward/Reverse		
1st Gear	10 km/h	6.2 mph
2nd Gear	35 km/h	21.7 mph
Creep Speed		
1st Gear	3 km/h	1.9 mph
2nd Gear	12 km/h	7.5 mph
Drawbar Pull	103 kN	23,155 lbf
Maximum Gradeability	64%	

Service Refill Capacities

Fuel Tank (total capacity)	330 L	87.2 gal
Diesel Exhaust Fluid Tank	34.5 L	9.1 gal
Cooling System	46.9 L	12.4 gal
Engine Crankcase	18.5 L	4.9 gal
Rear Axle Housing (differential)	14 L	3.7 gal
Front Steering Axle (differential)	10.5 L	2.8 gal
Final Drive	2.5 L	0.7 gal
Powershift Transmission	2.5 L	0.7 gal

Swing Mechanism

Swing Speed	10 rpm	
Swing Torque	38 kN·m	28,027 lbf-ft

Undercarriage

Ground Clearance	370 mm	14.6 in
Maximum Steering Angle	35°	
Oscillation Axle Angle	±9°	
Minimum Turning Radius		
Standard Axle		
Outside of Tire	6400 mm	21.0 ft
End of VA Boom	7000 mm	23.0 ft
End of One-Piece Boom	8300 mm	27.2 ft
End of Offset Boom	7000 mm	23.0 ft
Wide Axle		
Outside of Tire	6550 mm	21.5 ft
End of VA Boom	7100 mm	23.3 ft
End of One-Piece Boom	8500 mm	27.9 ft
End of Offset Boom	7100 mm	23.3 ft

Weights

Operating Weights*	16 900 kg- 19 700 kg	37,258 lb- 43,431 lb
Weights		
VA Boom		
Rear Dozer Only	17 400 kg	38,360 lb
Rear Dozer, Front Outriggers	18 410 kg	40,587 lb
Front and Rear Outriggers	18 670 kg	41,160 lb
One-Piece Boom		
Rear Dozer, Front Outriggers	17 920 kg	39,507 lb
Front and Rear Outriggers	18 180 kg	40,080 lb
Offset Boom		
Rear Dozer Only	17 950 kg	39,573 lb
Rear Dozer, Front Outriggers	18 950 kg	41,778 lb
Front and Rear Outriggers	19 210 kg	42,351 lb
Sticks**		
Short, 2100 mm (6'11")	700 kg	1,543 lb
Medium, 2400 mm (7'10")	730 kg	1,609 lb
Long, 2600 mm (8'6")	750 kg	1,653 lb
Industrial, 3100 mm (10'2")	410 kg	904 lb
Counterweight		
Standard	3400 kg	7,496 lb
Optional	3900 kg	8,598 lb

*Operating weight includes medium stick, 3400 kg (7,496 lb) counterweight, full fuel tank, operator, 200 kg (441 lb) quick coupler, 600 kg (1,323 lb) bucket and dual pneumatic tires. Weight varies depending on configuration.

**Includes cylinder, bucket linkage, pins and standard hydraulic lines.

M318F Wheeled Excavator Specifications

Hydraulic System

Tank Capacity	122 L	32.2 gal
System	210 L	55.5 gal
Maximum Pressure		
Implement Circuit		
Normal	350 bar	5,076 psi
Heavy Lift	370 bar	5,366 psi
Travel Circuit	350 bar	5,076 psi
Auxiliary Circuit		
High Pressure	350 bar	5,076 psi
Medium Pressure	210 bar	3,046 psi
Swing Mechanism	370 bar	5,366 psi
Maximum Flow		
Implement/Travel Circuit	252 L/min	67 gal/min
Auxiliary Circuit		
High Pressure	252 L/min	66.6 gal/min
Medium Pressure	49 L/min	12.9 gal/min
Swing Mechanism	85 L/min	22.5 gal/min

Tires

Standard	10.00-20 (Dual Pneumatic)
Optional	11.00-20 (Dual Pneumatic) 445/70/R19.5 TL XF (Single Pneumatic) 10.00-20 (Dual Solid Rubber)

Blade

Blade Type	Parallel	
Blade Roll-Over Height	576 mm	22.7 in
Width (standard axles)	2550 mm	100.4 in
Width (wide axles)	2750 mm	108.3 in

Sustainability

Engine Emissions	Tier 4 Final	
Fluids (Optional)		
Cat Bio HYDO Advanced	Readily biodegradable EU Flower eco-label certified	
Biodiesel up to B20	Meets EN 14214 or ASTM D6751 with EN590 or ASTM D975 Standard Mineral diesel fuels	
Vibration Levels		
Maximum Hand/Arm		
ISO 5349:2001	<2.5 m/s ²	<8.2 ft/s ²
Maximum Whole Body		
ISO/TR 25398:2006	<0.5 m/s ²	<1.6 ft/s ²
Seat Transmissibility Factor		
ISO 7096:2000-spectral class EM5	<0.7	

Standards

ROPS	ROPS (Rollover Protective Structure) offered by Caterpillar meets ROPS criteria ISO 12117-2:2008
FOPS	FOPS (Falling Object Protective Structure) meets FOPS criteria ISO 10262:1998 and SAE J1356:2008
Cab/Sound Levels	Meets appropriate standards as listed

Sound Performance

Operator Sound	
2000/14/EC	71 dB(A)
Spectator Sound	
2000/14/EC	100 dB(A)

- Operator Sound – The operator sound level is measured according to the procedures specified in 2000/14/EC, for a cab offered by Caterpillar, when properly installed and maintained and tested with the door and windows closed.
- Exterior Sound – The labeled spectator sound power level is measured according to the test procedures and conditions specified in 2000/14/EC.
- Hearing protection may be needed when operating with an open operator station and cab (when not properly maintained for doors/windows open) for extended periods or in noisy environment(s).

Blade

Blade Type	Parallel	
Blade Options – Width	2550 mm, 2750 mm	100.4 in, 108.3 in
Blade Total Height	680 mm	2'3"
Maximum Lowering Depth from Ground	131 mm	5"
Maximum Raising Height above Ground	496 mm	1'7"

M318F Wheeled Excavator Specifications

Dimensions

All dimensions are approximate.

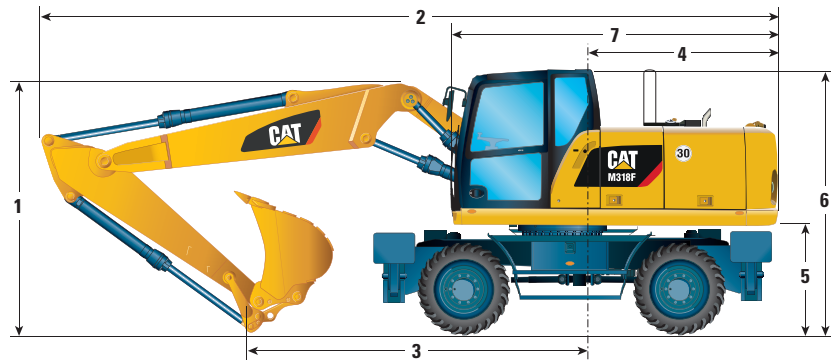

Stick Length	mm (ft/in)	VA Boom				One-Piece Boom				Offset Boom		
		2100 (6'11")	2400 (7'10")	2600 (8'6")	3100* (10'2")	2100 (6'11")	2400 (7'10")	2600 (8'6")	3100* (10'2")	2100 (6'11")	2400 (7'10")	
1 Shipping Height with Falling Object Guard and Handrails Lowered (highest point between boom and cab)	mm (ft/in)	3305 (10'10")				3305 (10'10")				3305 (10'10")		
2 Shipping Length	mm (ft/in)	8610 (28'3")	8610 (28'3")	8600 (28'3")	8580 (28'2")	8450 (27'9")	8460 (27'9")	8460 (27'9")	8480 (27'10")	8600 (28'3")	8560 (28'1")	
3 Support Point	mm (ft/in)	3910 (12'10")	3650 (12'0")	3550 (11'8")	3640 (11'11")	3560 (11'8")	3270 (10'9")	3150 (10'4")	3220 (10'7")	4010 (13'2")	3770 (12'4")	
4 Tail Swing Radius	mm (ft/in)	2300 (7'6")										
5 Counterweight Clearance	mm (ft/in)	1280 (4'2")										
6 Cab Height – No Falling Object Guard, Handrails Lowered	mm (ft/in)	3190 (10'6")										
	With Handrails not Lowered	mm (ft/in)	3270 (10'9")									
	With Falling Object Guard	mm (ft/in)	3305 (10'10")									
7 Overall Machine Width	Standard Axle	mm (ft/in)	2550 (8'4")									
	Wide Gauge Axle	mm (ft/in)	2750 (9'0")									

*3100 mm (10'2") industrial stick will be available in 2015.

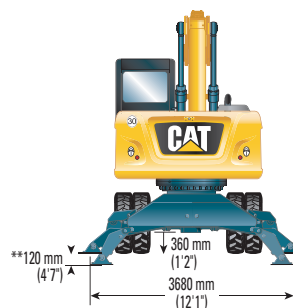
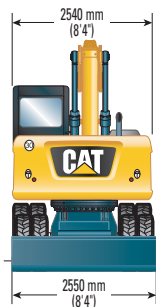

** Maximum tire clearance with outrigger fully down

Undercarriage with 2 sets of outriggers

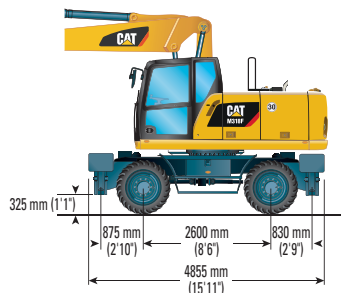

Undercarriage with 1 set of outriggers and dozer

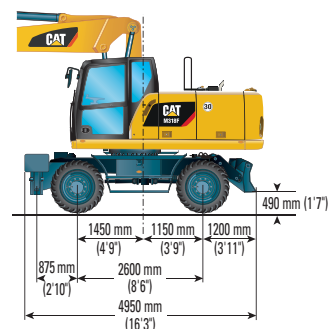

M318F Wheeled Excavator Specifications

Working Ranges

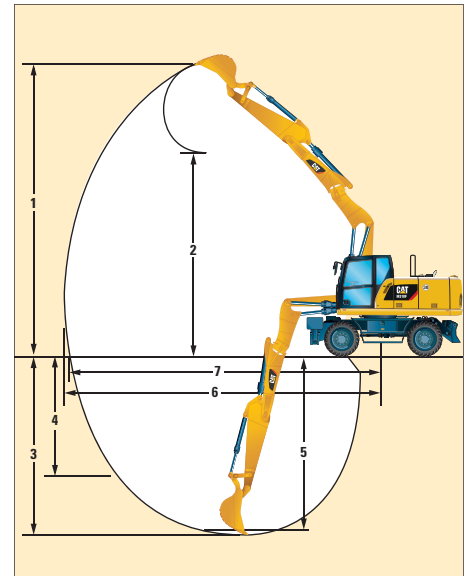
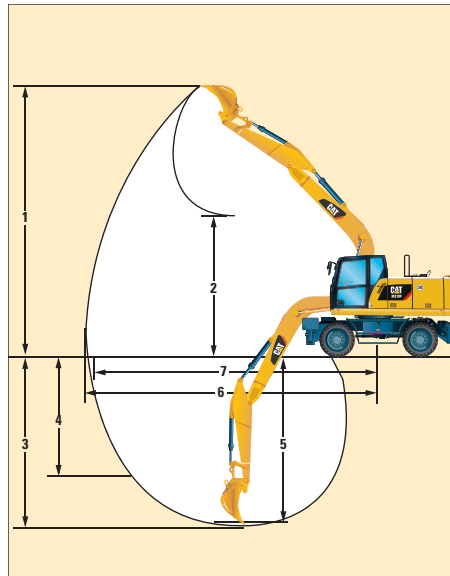
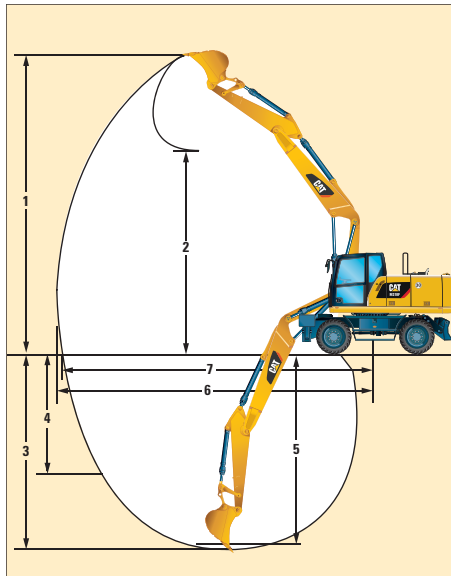

Stick Length	mm (ft/in)	VA Boom				One-Piece Boom				Offset Boom	
		2100 (6'11")	2400 (7'10")	2600 (8'6")	3100* (10'2")	2100 (6'11")	2400 (7'10")	2600 (8'6")	3100* (10'2")	2100 (6'11")	2400 (7'10")
1 Digging Height	mm (ft/in)	10 090 (33'1")	10 275 (33'9")	10 435 (34'3")	8970 (29'5")	9045 (29'8")	9140 (30'0")	9255 (30'4")	7720 (25'4")	10 125 (33'3")	10 320 (33'10")
2 Dump Height	mm (ft/in)	6945 (22'9")	7135 (23'5")	7265 (23'10")	3980 (13'1")	6000 (19'8")	6110 (20'1")	6225 (20'5")	3200 (10'6")	6980 (22'11")	7175 (23'6")
3 Digging Depth	mm (ft/in)	5595 (18'4")	5890 (19'4")	6090 (20'0")	5030 (16'6")	5390 (17'8")	5690 (18'8")	5890 (19'4")	4820 (15'10")	5600 (18'4")	5895 (19'4")
4 Vertical Wall Digging Depth	mm (ft/in)	4365 (14'4")	4600 (15'1")	4780 (15'8")	—	4490 (14'9")	4665 (15'4")	4845 (15'11")	—	4410 (14'6")	4650 (15'3")
5 Depth 2.5 m (8'2") in Straight Clean-Up	mm (ft/in)	5485 (18'0")	5785 (19'0")	5985 (19'8")	—	5170 (17'0")	5490 (18'0")	5700 (18'8")	—	5490 (18'0")	5790 (19'0")
6 Reach	mm (ft/in)	9120 (29'11")	9385 (30'9")	9580 (31'5")	8370 (27'6")	8920 (29'3")	9175 (30'1")	9365 (30'9")	8130 (26'8")	9135 (30'0")	9405 (30'10")
7 Reach at Ground Level	mm (ft/in)	8935 (29'4")	9210 (30'3")	9405 (30'10")	8170 (26'10")	8730 (28'8")	8995 (29'6")	9190 (30'2")	7920 (26'0")	8950 (29'4")	9225 (30'3")
Bucket Forces (ISO 6015)	kN (lbf)	101 (22,705)				101 (22,705)				101 (22,705)	
Stick Forces (ISO 6015)	kN (lbf)	81 (8,209)	74 (16,635)	71 (15,961)	—	81 (8,209)	74 (16,635)	71 (15,961)	—	81 (8,209)	74 (16,635)

Range values are calculated with GD Bucket, 1200 mm (48 in), 0.91 m³ (1.19 yd³) with tips K080 and CW-20-H.4.N. quick coupler with a tip radius of 1574 mm (5'2").

Bucket and Stick force values are calculated with heavy lift on (no quick coupler) and a tip radius of 1404 mm (4'7").

*3100 mm (10'2") industrial stick will be available in 2015. Industrial stick has no bucket linkage. All dimensions refer to stick nose.







M318F Wheeled Excavator Specifications

Bucket Specifications and Compatibility

Contact your Cat dealer for special bucket requirements.

Without Quick Coupler				Variable Adjustable Boom									One-Piece Boom				Offset Boom			
Counterweight				3.4 mt (7,496 lb)									3.4 mt (7,496 lb)				3.9 mt (8,598 lb)			
Stick Length				2100 mm (6'11")			2400 mm (7'10")			2600 mm (8'6")			2400 mm (7'10")		2600 mm (8'6")		2100 mm (6'11")		2400 mm (7'10")	
	Width	Capacity	Weight	Free on wheels	Dozer lowered	1 set of stabilizers lowered	Fully stabilized	Free on wheels	Dozer lowered	1 set of stabilizers lowered	Fully stabilized	Free on wheels	Dozer lowered	1 set of stabilizers lowered	Fully stabilized	Free on wheels	Dozer lowered	1 set of stabilizers lowered	Fully stabilized	
				mm (in)	m ³ (yd ³)	kg (lb)														
General Duty (GD)	750 (30)	0.49 (0.64)	464 (1,022)																	
	1100 (43)	0.79 (1.03)	583 (1,285)																	
	1200 (48)	0.91 (1.19)	651 (1,435)																	
	1300 (51)	1.00 (1.31)	663 (1,462)																	
	1400 (55)	1.09 (1.43)	712 (1,570)																	
Heavy Duty (HD)	1300 (51)	1.00 (1.31)	699 (1,541)																	
Ditch Cleaning (DC)	2000 (78)	0.54 (0.71)	431 (950)																	
Ditch Cleaning Tilt (DCT)	1800 (71)	0.48 (0.63)	567 (1,250)																	
	2000 (78)	0.53 (0.69)	597 (1,316)																	

The above loads are in compliance with hydraulic excavator standard EN474, they do not exceed 87% of hydraulic lifting capacity or 75% of tipping capacity with front linkage fully extended at ground line with bucket curled.
Capacity based on ISO 7451.
Bucket weight with General Duty tips.

-  Maximum material density 2100 kg/m³ (3,500 lb/yd³)
-  Maximum material density 1800 kg/m³ (3,000 lb/yd³)
-  Maximum material density 1500 kg/m³ (2,500 lb/yd³)
-  Maximum material density 1200 kg/m³ (2,000 lb/yd³)
-  Maximum material density 900 kg/m³ (1,500 lb/yd³)
-  Not recommended

Caterpillar recommends using appropriate work tools to maximize the value customers receive from our products. Use of work tools, including buckets, which are outside of Caterpillar's recommendations or specifications for weight, dimensions, flows, pressures, etc. may result in less-than-optimal performance, including but not limited to reductions in production, stability, reliability, and component durability. Improper use of a work tool resulting in sweeping, prying, twisting and/or catching of heavy loads will reduce the life of the boom and stick.

M318F Wheeled Excavator Specifications

Bucket Specifications and Compatibility

Contact your Cat dealer for special bucket requirements.

With Pin Grabber Coupler				Variable Adjustable Boom						One-Piece Boom				Offset Boom						
Counterweight				3.4 mt (7,496 lb)						3.4 mt (7,496 lb)				3.9 mt (8,598 lb)						
Stick Length				2100 mm (6'11")		2400 mm (7'10")		2600 mm (8'6")		2400 mm (7'10")		2600 mm (8'6")		2100 mm (6'11")		2400 mm (7'10")				
	Width	Capacity	Weight	Free on wheels		Dozer lowered		1 set of stabilizers lowered		Fully stabilized		Free on wheels		Dozer lowered		1 set of stabilizers lowered		Fully stabilized		
				mm (in)	m ³ (yd ³)	kg (lb)	Free on wheels	Dozer lowered	1 set of stabilizers lowered	Fully stabilized	Free on wheels	Dozer lowered	1 set of stabilizers lowered	Fully stabilized	Free on wheels	Dozer lowered	1 set of stabilizers lowered	Fully stabilized	Free on wheels	Dozer lowered
General Duty (GD)	750 (30)	0.49 (0.64)	464 (1,022)	Orange	Orange	Orange	Orange	Orange	Orange	Orange	Orange	Orange	Orange	Orange	Orange	Orange	Orange	Orange	Orange	Orange
	1100 (43)	0.79 (1.03)	583 (1,285)	Green	Orange	Orange	Orange	Orange	Orange	Orange	Orange	Green	Orange	Orange	Orange	Orange	Orange	Orange	Orange	Orange
	1200 (48)	0.91 (1.19)	651 (1,435)	Green	Orange	Orange	Orange	Orange	Orange	Orange	Orange	Green	Orange	Orange	Orange	Orange	Orange	Orange	Orange	Orange
	1300 (51)	1.00 (1.31)	663 (1,462)	Green	Orange	Orange	Orange	Orange	Orange	Orange	Orange	Green	Orange	Orange	Orange	Orange	Orange	Orange	Orange	Orange
	1400 (55)	1.09 (1.43)	712 (1,570)	Green	Orange	Orange	Orange	Orange	Orange	Orange	Orange	Green	Orange	Orange	Orange	Orange	Orange	Orange	Orange	Orange
Heavy Duty (HD)	1300 (51)	1.00 (1.31)	699 (1,541)	Green	Orange	Orange	Orange	Orange	Orange	Orange	Orange	Green	Orange	Orange	Orange	Orange	Orange	Orange	Orange	Orange
Ditch Cleaning (DC)	2000 (78)	0.54 (0.71)	431 (950)	Blue	Orange	Orange	Orange	Orange	Orange	Orange	Orange	Blue	Orange	Orange	Orange	Orange	Orange	Orange	Orange	Orange
Ditch Cleaning Tilt (DCT)	1800 (71)	0.48 (0.63)	567 (1,250)	Blue	Orange	Orange	Orange	Orange	Orange	Orange	Orange	Blue	Orange	Orange	Orange	Orange	Orange	Orange	Orange	Orange
	2000 (78)	0.53 (0.69)	597 (1,316)	Blue	Orange	Orange	Orange	Orange	Orange	Orange	Orange	Blue	Orange	Orange	Orange	Orange	Orange	Orange	Orange	Orange

The above loads are in compliance with hydraulic excavator standard EN474, they do not exceed 87% of hydraulic lifting capacity or 75% of tipping capacity with front linkage fully extended at ground line with bucket curled.

Capacity based on ISO 7451.

Bucket weight with General Duty tips.

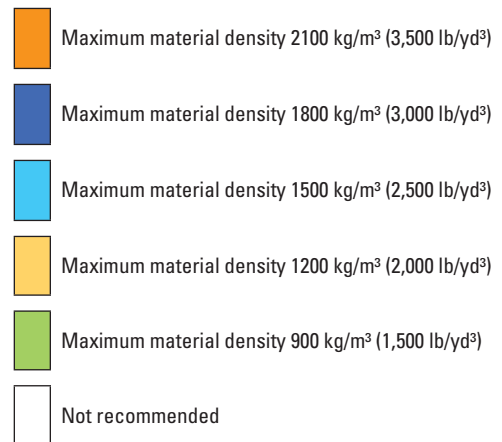

Caterpillar recommends using appropriate work tools to maximize the value customers receive from our products. Use of work tools, including buckets, which are outside of Caterpillar's recommendations or specifications for weight, dimensions, flows, pressures, etc. may result in less-than-optimal performance, including but not limited to reductions in production, stability, reliability, and component durability. Improper use of a work tool resulting in sweeping, prying, twisting and/or catching of heavy loads will reduce the life of the boom and stick.

M318F Wheeled Excavator Specifications

Work Tools Matching Guide

When choosing between various work tool models that can be installed onto the same machine configuration, consider work tool application, productivity requirements, and durability. Refer to work tool specifications for application recommendations and productivity information.

Counterweight		Variable Adjustable Boom																																															
		3.4 mt (7,496 lb)												3.9 mt (8,598 lb)																																			
Stick Length		(1)				(2)				(3)				(1)				(2)				(3)																											
		2100 mm (6'11")	2400 mm (7'10")	2600 mm (8'6")	3100 mm (10'2")	2100 mm (6'11")	2400 mm (7'10")	2600 mm (8'6")	3100 mm (10'2")	2100 mm (6'11")	2400 mm (7'10")	2600 mm (8'6")	3100 mm (10'2")	2100 mm (6'11")	2400 mm (7'10")	2600 mm (8'6")	3100 mm (10'2")	2100 mm (6'11")	2400 mm (7'10")	2600 mm (8'6")	3100 mm (10'2")	2100 mm (6'11")	2400 mm (7'10")	2600 mm (8'6")	3100 mm (10'2")																								
Hydraulic Hammer	H110Es	Grey	Grey	Grey		Grey	Grey	Grey		Grey	Grey	Grey		Grey	Grey	Grey		Grey	Grey	Grey		Grey	Grey	Grey																									
	H115Es	Grey	Grey	Grey		Grey	Grey	Grey		Grey	Grey	Grey		Grey	Grey	Grey		Grey	Grey	Grey		Grey	Grey	Grey																									
	H120Es	Orange	Orange	Orange	Red	Grey	Grey	Grey		Grey	Grey	Grey		Yellow	Orange	Orange		Grey	Grey	Grey		Grey	Grey	Grey																									
Demolition and Sorting Grapple (D-Demolition shells, R-Recycling shells)	G310B-D/R	Green	Light Blue	Orange		Grey	Grey	Grey		Grey	Grey	Grey		Yellow	Green	Green		Grey	Grey	Grey		Grey	Grey	Grey																									
	G315B-D/R					Orange	Orange	Orange		Orange	Orange	Orange						Orange	Orange	Orange		Orange	Orange	Orange																									
Scrap and Demolition Shear	S320B	Blue	Blue	Blue	Blue	Blue	Blue	Blue	Blue	Blue	Blue	Blue	Blue	Blue	Blue	Blue	Blue	Blue	Blue	Blue	Blue	Blue	Blue	Blue	Blue																								
	S325B	Blue	Blue	Blue	Blue	Blue	Blue	Blue	Blue	Blue	Blue	Blue	Blue	Blue	Blue	Blue	Blue	Blue	Blue	Blue	Blue	Blue	Blue	Blue	Blue																								
Compactor Plate	CVP75	Grey	Grey	Grey		Grey	Grey	Grey		Grey	Grey	Grey		Grey	Grey	Grey		Grey	Grey	Grey		Grey	Grey	Grey																									
Orange Peel Grapple (4 or 5 Tines)	GSH15B 400 L (1/2 yd³)	These work tools are available for the M318F. Consult your Cat dealer for proper match.																																															
	GSH15B 500 L (5/8 yd³)																																																
	GSH15B 600 L (3/4 yd³)																																																
	GSH15B 800 L (1 yd³)																																																
Trash Grapple	These work tools are available for the M318F. Consult your Cat dealer for proper match.																																																
Thumbs																																																	
Rakes																																																	
Pin Grabber Coupler																										CL-QC																							
Dedicated Quick Coupler																										CW-20																							
																										CW-20S																							

- (1) Dozer lowered
 - (2) 2 sets outriggers lowered
 - (3) Dozer and outrigger lowered
- Work Tool is a match
 - Pin-on or dedicated coupler
 - Pin-on only
 - Over the front only
 - Boom Mount
 - Over the front only with dedicated coupler
 - Over the front only with CL coupler
 - Not recommended

Offerings not available in all areas. Matches are dependent on Wheeled Excavator configurations. Consult your Cat dealer to determine what is offered in your area and for proper work tool match.

M318F Wheeled Excavator Specifications

Work Tools Matching Guide

When choosing between various work tool models that can be installed onto the same machine configuration, consider work tool application, productivity requirements, and durability. Refer to work tool specifications for application recommendations and productivity information.

Counterweight		One-Piece Boom																						
		3.4 mt (7,496 lb)						3.9 mt (8,598 lb)																
Stick Length		(1)			(2)			(3)			(1)			(2)			(3)							
		2100 mm (6'11")	2400 mm (7'10")	2600 mm (8'6")	3100 mm (10'2")	2100 mm (6'11")	2400 mm (7'10")	2600 mm (8'6")	3100 mm (10'2")	2100 mm (6'11")	2400 mm (7'10")	2600 mm (8'6")	3100 mm (10'2")	2100 mm (6'11")	2400 mm (7'10")	2600 mm (8'6")	3100 mm (10'2")	2100 mm (6'11")	2400 mm (7'10")	2600 mm (8'6")	3100 mm (10'2")			
Hydraulic Hammer	H110Es	Grey	Grey	Grey		Grey	Grey	Grey		Grey	Grey	Grey		Grey	Grey	Grey		Grey	Grey	Grey		Grey	Grey	Grey
	H115Es	Grey	Grey	Grey		Grey	Grey	Grey		Grey	Grey	Grey		Grey	Grey	Grey		Grey	Grey	Grey		Grey	Grey	Grey
	H120Es	Yellow	Blue	Orange		Grey	Grey	Grey		Grey	Grey	Grey		Grey	Yellow	Green		Grey	Grey	Grey		Grey	Grey	Grey
Multi-Processor	MP318 CC Jaw					Orange	Orange	Orange		Orange	Orange	Orange		Orange	Orange	Orange		Orange	Orange	Orange		Orange	Orange	Orange
	MP318 D Jaw					Orange	Orange	Orange		Orange	Orange	Orange		Orange	Orange	Orange		Orange	Orange	Orange		Orange	Orange	Orange
	MP318 S Jaw	Red				Orange	Orange	Orange		Orange	Orange	Orange		Orange	Orange	Orange		Orange	Orange	Orange		Orange	Orange	Orange
Crusher	P315					Orange	Orange	Orange		Orange	Orange	Orange		Orange	Orange	Orange		Orange	Orange	Orange		Orange	Orange	Orange
Pulverizer	P215	Orange	Orange	Red		Green	Orange	Orange		Green	Orange	Orange		Green	Orange	Orange		Green	Orange	Orange		Green	Orange	Orange
Demolition and Sorting Grapple (D-Demolition shells, R-Recycling shells)	G310B-D/R	Yellow	Green	Green		Grey	Grey	Grey		Grey	Grey	Grey		Grey	Grey	Grey		Grey	Grey	Grey		Grey	Grey	Grey
	G315B-D/R					Green	Orange			Green	Orange			Red	Red			Green	Orange	Orange		Green	Orange	Orange
Scrap and Demolition Shear	S320B	Blue	Blue	Blue	Blue	Blue	Blue	Blue	Blue	Blue	Blue	Blue	Blue	Blue	Blue	Blue	Blue	Blue	Blue	Blue	Blue	Blue	Blue	Blue
	S325B	Blue	Blue	Blue	Blue	Blue	Blue	Blue	Blue	Blue	Blue	Blue	Blue	Blue	Blue	Blue	Blue	Blue	Blue	Blue	Blue	Blue	Blue	Blue
Compactor Plate	CVP75	Grey	Grey	Grey		Grey	Grey	Grey		Grey	Grey	Grey		Grey	Grey	Grey		Grey	Grey	Grey		Grey	Grey	Grey

- (1) Dozer lowered
 - (2) 2 sets outriggers lowered
 - (3) Dozer and outrigger lowered
- Work Tool is a match
 - Pin-on or dedicated coupler
 - Pin-on only
 - Over the front only
 - Boom Mount
 - Over the front only with dedicated coupler
 - Over the front only with CL coupler
 - Not recommended

Offerings not available in all areas. Matches are dependent on Wheeled Excavator configurations. Consult your Cat dealer to determine what is offered in your area and for proper work tool match.

M318F Wheeled Excavator Specifications

Lift Capacities – One-Piece Boom

All values are in kg, bucket cylinder and bucket linkage installed, work tool: none, with counterweight (3900 kg), heavy lift on.

Long Stick 2600 mm	Load at maximum reach (stick nose/bucket pin)	Load over front	Load over rear	Load over side	Load point height	Undercarriage configuration												
						3000 mm			4500 mm			6000 mm			7500 mm			mm
						Front	Rear	Side	Front	Rear	Side	Front	Rear	Side	Front	Rear	Side	
6000 mm	Rear dozer up Rear dozer down Dozer and stabilizer down 2 sets of stabilizers down								*4350	3400	3000				*2950	*2950	2600	6490
4500 mm	Rear dozer up Rear dozer down Dozer and stabilizer down 2 sets of stabilizers down								4750	3350	2950				*2800	2450	2150	7280
3000 mm	Rear dozer up Rear dozer down Dozer and stabilizer down 2 sets of stabilizers down				7150	4950	4300	4600	3250	2850	3300	2300	2000	*2800	2200	1900	1900	7690
1500 mm	Rear dozer up Rear dozer down Dozer and stabilizer down 2 sets of stabilizers down				6800	4600	4000	4450	3100	2700	3200	2250	1950	*2950	2100	1850	1850	7790
0 mm	Rear dozer up Rear dozer down Dozer and stabilizer down 2 sets of stabilizers down	*4400	*4400	*4400	6600	4450	3800	4350	3000	2600	3200	2200	1900	3150	2150	1900	1900	7580
-1500 mm	Rear dozer up Rear dozer down Dozer and stabilizer down 2 sets of stabilizers down	*8200	*8200	6750	6550	4400	3750	4300	2950	2550				3450	2400	2100	2100	7030
-3000 mm	Rear dozer up Rear dozer down Dozer and stabilizer down 2 sets of stabilizers down	*9200	8350	6900	6600	4450	3800	4350	3000	2600				4300	2950	2550	2550	6060

*Limited by hydraulic rather than tipping load.

Lift capacity ratings are based on ISO 10567:2007, they do not exceed 87% of hydraulic lifting capacity or 75% of tipping load. The load point is the center line of the bucket pivot mounting pin on the stick. The oscillating axle must be locked. Lifting capacities are based on the machine standing on a firm uniform supporting surface. For lifting capacity including bucket and/or quick coupler, the respective weight has to be subtracted from above values. The use of a work tool attachment point to handle/lift objects, could affect the machine lift performance.

Always refer to the appropriate Operation and Maintenance Manual for specific product information.

M318F Wheeled Excavator Specifications

Lift Capacities – One-Piece Boom

All values are in lb, bucket cylinder and bucket linkage installed, work tool: none, with counterweight (8,598 lb), heavy lift on.

Long Stick 8'6"	Undercarriage configuration	Load at maximum reach (stick nose/bucket pin)			Load over front			Load over rear			Load over side			Load point height			ft				
		5 ft			10 ft			15 ft			20 ft			25 ft							
		Stick	Quick Coupler	Bucket	Stick	Quick Coupler	Bucket	Stick	Quick Coupler	Bucket	Stick	Quick Coupler	Bucket	Stick	Quick Coupler	Bucket					
25 ft	Rear dozer up																	*7,600	*7,600	*7,600	16.34
	Rear dozer down																	*7,600	*7,600	*7,600	
	Dozer and stabilizer down 2 sets of stabilizers down																	*7,600	*7,600	*7,600	
20 ft	Rear dozer up																	*6,500	*6,500	*6,500	21.06
	Rear dozer down																	*6,500	*6,500	*6,500	
	Dozer and stabilizer down 2 sets of stabilizers down																	*6,500	*6,500	*6,500	
15 ft	Rear dozer up																	*6,500	*6,500	*6,500	23.79
	Rear dozer down																	*6,500	*6,500	*6,500	
	Dozer and stabilizer down 2 sets of stabilizers down																	*6,500	*6,500	*6,500	
10 ft	Rear dozer up																	*6,200	*6,200	*6,200	25.20
	Rear dozer down																	*6,200	*6,200	*6,200	
	Dozer and stabilizer down 2 sets of stabilizers down																	*6,200	*6,200	*6,200	
5 ft	Rear dozer up																	*6,200	*6,200	*6,200	25.56
	Rear dozer down																	*6,200	*6,200	*6,200	
	Dozer and stabilizer down 2 sets of stabilizers down																	*6,200	*6,200	*6,200	
0 ft	Rear dozer up																	*6,200	*6,200	*6,200	24.87
	Rear dozer down																	*6,200	*6,200	*6,200	
	Dozer and stabilizer down 2 sets of stabilizers down																	*6,200	*6,200	*6,200	
-5 ft	Rear dozer up																	*6,200	*6,200	*6,200	23.03
	Rear dozer down																	*6,200	*6,200	*6,200	
	Dozer and stabilizer down 2 sets of stabilizers down																	*6,200	*6,200	*6,200	
-10 ft	Rear dozer up																	*6,200	*6,200	*6,200	19.75
	Rear dozer down																	*6,200	*6,200	*6,200	
	Dozer and stabilizer down 2 sets of stabilizers down																	*6,200	*6,200	*6,200	

*Limited by hydraulic rather than tipping load.

Lift capacity ratings are based on ISO 10567:2007, they do not exceed 87% of hydraulic lifting capacity or 75% of tipping load. The load point is the center line of the bucket pivot mounting pin on the stick. The oscillating axle must be locked. Lifting capacities are based on the machine standing on a firm uniform supporting surface. For lifting capacity including bucket and/or quick coupler, the respective weight has to be subtracted from above values. The use of a work tool attachment point to handle/lift objects, could affect the machine lift performance.

Always refer to the appropriate Operation and Maintenance Manual for specific product information.

Standard Equipment

Standard equipment may vary. Consult your Cat dealer for details.

ELECTRICAL

- Alternator, 115 A
- Lighting
 - LED light package, including all working lights (compatible with falling object guard)
 - Boom working light
 - Cab interior LED Light
 - Rooding lights two front
 - Rooding lights two LED modules rear
 - Working lights, cab mounted (two front, one rear, and one counterweight for the rear camera)
- Main shut-off switch
- Maintenance free batteries, heavy duty
- Signal/warning horn
- Electrical refueling pump

ENGINE

- Cat C7.1 engine with ACERT Technology Tier 4 Final compliant
- Aftertreatment technologies including the Cat Emission Module package (CEM)
- Automatic Engine Speed Control (AESC), including one touch low idle
- Engine Idle Shutdown (EIS)
- Power mode selector
- Altitude 3000 m (9,842 ft)
- Automatic starting aid
- Fuel/water separator with water in fuel switch

HYDRAULICS

- Adjustable hydraulic sensitivity
- All Cat XT™-6 ES hoses
- Anti-drift valves for bucket, and tool control/multi-function circuits
- Basic control circuits:
 - Medium pressure
 - Two-way, medium pressure circuit, for rotating or tilting of work tools
 - Tool control/multi function
 - One/two-way high pressure for hammer application or opening and closing of a work tool
 - Programmable flow and pressure for up to 10 work tools – selection via monitor
 - Quick coupler circuit and lines for hydraulic quick coupler
- BLCV including overload warning device

- Heavy lift mode
- Load-sensing hydraulic system
- Separate swing pump
- SLCV
- Stick regeneration circuit

OPERATOR STATION

- ROPS cab structure compliant with 2006/42/EC and tested according to ISO 12117-2:2008
- Adjustable armrests
- Air conditioner, heater and defroster with automatic climate control
- Cigarette lighter (24 volt)
- Beverage cup/can holder
- Bolt-on FOGS capability
- Bottle holder
- Bottom mounted intermittent (four speeds) wiping system that covers the upper and lower windshield glass
- Cameras
 - Rear mounted wide angle camera (integrated into the counterweight) display through the cab monitor
 - Right side wide angle camera, mounted on the cooling hood, displayed on a dedicated color large monitor
- Coat hook
- Cruise Control System
- Fastened seat belt warning signal
- Floor mat, washable, with storage compartment
- FM Radio with CD player, speakers and USB port
- Fully adjustable suspension seat
- Instrument panel and gauges
 - Information and warning messages in local language
 - Gauges for fuel level, engine coolant, Diesel Exhaust Fluid (DEF) and hydraulic oil temperature
 - Filters/fluids change intervals
 - Indicators for headlights, turning signal, low fuel, engine dial setting
 - Clock with 10-day backup battery
- Interior LED lighting with door switch
- Joystick pilot operated
- Laminated upper front windshield
- Left side console, tiltable, with lock out for all controls

- Literature holder in right hand side panel
- Mobile phone holder
- Parking brake
- Pin-code, engine start prevention
- Power supply, 12V-10A
- Rain protector*
- Rear window, emergency, tempered glass, with hammer
- Retractable seat, integrated into the seat
- Safety lever, integrated into the left console
- Skylight, laminated glass
- Sealed cab with positive filtered ventilation
- Sliding door windows
- Steering column, adjustable height and angle
- Storage area suitable for a lunch box
- Sunshade for windshield and skylight

UNDERCARRIAGE

- All wheel drive
- Automatic axle/break lock
- Creeper speed
- Electronic swing and travel lock
- Heavy-duty axles, advanced disc brake system and travel motor, adjustable braking force
- Oscillating front axle, lockable, with remote greasing point
- Tires, 10.00-20 16 PR, dual
- Steps with box in undercarriage (left and right)
- Two-piece drive shaft
- Two speed hydrostatic transmission

OTHER EQUIPMENT

- Auto-lube, centralized greasing (implement and swing gear)
- Automatic swing brake
- Counterweight, 3400 kg (7,496 lb)
- Engine emergency shutoff switch
- Mirrors, wide angle, frame and cab
- Product Link
- S•O•SSM sampling valves for engine oil, hydraulic oil and coolant

*Not compatible with the falling objects guards

M318F Wheeled Excavator Optional Equipment

Optional Equipment

Optional equipment may vary. Consult your Cat dealer for details.

AUXILIARY CONTROLS AND LINES

- Basic control circuits:
 - Second high pressure
 - Additional two-way, high pressure circuit, for tools requiring a second high or medium pressure function
- Cat BIO HYDO Advanced HEES biodegradable hydraulic oil
- SmartBoom

FRONT LINKAGE

- Booms
 - One-piece boom, 5050 mm (16'6")
 - VA boom (two piece), 5200 mm (17'1")
 - Offset boom, 5200 mm (17'1")
- Sticks
 - 2100 mm (6'11")
 - 2400 mm (7'10")
 - 2600 mm (8'6")
 - 3100 mm (10'2") Industrial Stick*

ELECTRICAL

- Back-up alarm with three selectable modes
- Rotating beacon on cab

OPERATOR STATION

- Joystick steering
- Seat, adjustable high-back
 - Comfort, air-suspension, heated (vertical)
 - Deluxe with headrest, air suspension, heated and ventilated
 - Headrest, on all seats
- Windshield
 - One-piece high impact resistant
 - 70/30 split, openable
- Mirrors heated, frame and cab

UNDERCARRIAGE

- Rear blade only
- Front blade/rear outriggers
- Front outriggers/rear blade
- Front and rear outriggers
- Spacer rings for tires
- Travel restraint
- Wide axles
- Wide rear blade
- Wide blade rear/outriggers front

OTHER EQUIPMENT

- Cat Machine Security System (MSS)
- Cooling protection package for dusty applications*
- Counterweight, 3900 kg (8,598 lb)
- Fenders, front and rear
- Ride Control
- Tires (see pg. 22)
- Attachments (see pg. 25-28)

*Available in 2015

For more complete information on Cat products, dealer services, and industry solutions, visit us on the web at www.cat.com

AEHQ7375 (01-2015)
(North America)

© 2015 Caterpillar
All rights reserved

Materials and specifications are subject to change without notice. Featured machines in photos may include additional equipment. See your Cat dealer for available options.

CAT, CATERPILLAR, SAFETY.CAT.COM, their respective logos, "Caterpillar Yellow" and the "Power Edge" trade dress, as well as corporate and product identity used herein, are trademarks of Caterpillar and may not be used without permission.

VisionLink is a trademark of Trimble Navigation Limited, registered in the United States and in other countries.

